

SCOOZY®

**INSTRUCTION MANUAL
SCOOZY C SERIES**

ENGLISH

Scoozy B.V.
Groothandelsweg 1
2645 EH Delfgauw
Nederland

Web www.en.scoozy.nl
E-mail info@scoozy.nl





Thank you for choosing Scoozy! With Scoozy you can get everything out of life and go on an adventure. You are in control and will discover ultimate freedom. There is nothing between you and the world.

With the information in this user manual you can use and maintain Scoozy safely. Please read the entire user manual carefully before using Scoozy.

A handwritten signature in black ink, appearing to read 'Job van de Kieft', with a stylized flourish at the end.

Kind regards,
Job van de Kieft CEO

If you are visually impaired and would like to receive this information in another way, please contact Scoozy at: www.en.scoozy.nl/contact.



TABLE OF CONTENTS

06 **1 SAFETY REGULATIONS**

1.1 Safety advice

12 **2 PRODUCT DESCRIPTION**

2.1 Features

2.1 Inspections

2.3 Indications

2.4 Versions and accessories

2.5 Weight and luggage

2.6 Before use

20 **3 USE**

3.1 Driving with Scoozy

3.2 User menu

3.3 Changing settings

3.4 Joystick controls

3.5 Freewheel

3.6 Operating functions

3.7 Parking and storage

3.8 Transportation of Scoozy

32	4 BATTERY All information on the battery
36	5 MAINTENANCE Keep Scoozy in top condition
40	6 NOTIFICATIONS Overview of notifications on the screen
42	7 WARRANTY CONDITIONS All conditions regarding the use of Scoozy
46	8 TECHNICAL SPECIFICATIONS Overview of the important specifications
48	9 SPECIFICATIONS TO ISO 7176: 15 ANNEX A All specifications based on the standard
50	10 MAINTENANCE HISTORY Space for comments from technicians
52	11 GENERAL General matters concerning Scoozy

1 SAFETY REGULATIONS

As a user of Scoozy, you are always responsible for complying with the locally applicable safety regulations and guidelines. It is important to first gain driving experience under the guidance of an experienced instructor. Ask your Scoozy dealer for help.

Scoozy accepts no liability for damage or injury caused by negligence or failure to comply with safety regulations.

You can find up-to-date notifications regarding product safety or possible recall actions on our website: www.en.scoozy.nl

INTENDED USE

Scoozy can be used as a Type C scooter. This means that Scoozy can mainly drive outdoors, on paved and unpaved roads and trails. If in doubt, please refer to this manual again.

SCOOZY IS DEVELOPED FOR:

- The transportation of one person weighing up to 150 kg with a maximum of 30 kg luggage;
- Use on sidewalks, pavements, bike paths, forest paths and roads (if allowed by local traffic laws);
- Indoor and outdoor use

Driver:

- The person on Scoozy is the driver.
- Scoozy may only be operated by the driver.
- If you are under the influence of substances that can affect your ability to drive (such as drugs, alcohol or medication), do not drive Scoozy.
- If you have insufficient eyesight, do not drive Scoozy.
- In the Netherlands it is mandatory to insure your Scoozy at least for third party liability.

Surrounding conditions

- Operating temperature between -25 °C* and +50 °C
- Relative humidity between 0% and 98%
- Storage environment temperature from -40 °C to +85 °C

* Limited functionality under 0 °C (see 4.1).

SCOOZY IS NOT DEVELOPED FOR:

- Use off unpaved roads and trails. This means that Scoozy has been developed as an all-road vehicle, not for off-road use.
- Use as a seat for transportation in a motorized vehicle;
- Use by children under 16 years of age;
- Pulling loads (such as trailers);
- Transporting more than one person;
- Surrounding conditions other than above.

AVOID PINCHING FINGERS AND LIMBS:

- While turning in the wheels;
- While closing the doors;
- During steering and maneuvering;
- If you have reduced control of your arms or legs.



1.1 SAFETY ADVICE

GENERAL

- Never change the construction of Scoozy.
- Never modify Scoozy's electrical system.
- Only use the luggage rack for transporting items.
- Use only original Scoozy parts and accessories.
- Using Scoozy to tow loads is at your own risk.
- Keep the protruding fixed or loose parts of, in and on Scoozy in mind. These can cause damage to the surroundings and Scoozy.
- Avoid physical contact with Scoozy's motors. The motors are constantly moving during use and can reach high temperatures. After use, the motor cools down slowly. Physical contact can cause burns.
- Stay away from open flames with Scoozy.
- Scoozy has fully programmable electronic steering. Changing this programming affects driving behaviour (see 3.3).
- Never cover or remove the safety instructions and stickers.
- Always leave Scoozy switched off and locked. This reduces the risk of unwanted use and/or theft.
- When storing your Scoozy, place a chain lock through one of the wheels for extra safety.
- Obey the applicable traffic rules.
- Make sure that you are always noticed by other road users. As a Scoozy user, you are vulnerable in traffic.
- Avoid remote routes. Have help available in case of an emergency.
- Shopping gates can be activated by Scoozy.

USE

- The technical specifications must never be changed.
- Do not put Scoozy in direct sunlight: the upholstery can become hot, possibly causing burning or sensitization of the skin.
- Do not let Scoozy come into contact with sea water; the salt in seawater affects the components of Scoozy.
- Always clean Scoozy carefully after riding on unpaved trails according to the instructions in chapter 5; sand can lead to unnecessarily rapid wear on Scoozy's moving parts.
- Scoozy is not made for driving in loose sand (e.g. the beach), not even the 4WD version.

A number of technical precautions have been taken to ensure your safety even more:

- The immobilizer is active when the battery charger is connected.
- When cornering, the steering angle is automatically limited depending on your speed.
- The freewheel is limited. Downhill, Scoozy will be limited after reaching maximum speed.
- The display warns you when the range is too low (number of kilometres to drive).
- The display provides you with information to correct any faults.
- When an electronic fault is detected, Scoozy will come to a controlled stop.
- Scoozy has an emergency stop on the control panel to bring it to a fast stop in case of an emergency.
- Parts in which body parts can get trapped, are shielded.
- A lap belt is provided to fix your posture and should always be worn while driving.

DRIVING WITH SCOOZY

- Drive carefully on roads that are slippery due to rain, ice or snow.
- Make sure that no items of clothing hang loose. These can get in between the wheels and thus lead to various problems.
- Do not hang anything on the armrests.
- Do not let anyone stand on the front or back of Scoozy.
- Be vigilant against tipping over:
 - When driving up a slope;
 - When driving down obstacles.
- Scoozy steers with the front wheels. The faster Scoozy drives, the smaller the steering angle.
- Watch out for tight corners: the rear of Scoozy cuts corners.

SLOPES AND OTHER OBSTACLES

- Avoid slopes greater than 10° . Driving it (forwards or backwards) is dangerous. Scoozy itself indicates when you are driving on a slope of $>10^\circ$ and adjusts its behaviour accordingly.
- Never use the freewheel on a slope!
- Always drive straight up and down a pavement. Carefully accelerate and take a run-up of 50cm. It is better to drive up a pavement via a ramp.
- Soft, slippery or uneven terrain increases the risk of dangerous situations.
- Drive carefully along a (pavement) edge. Uneven ground increases the risk of tipping.
- The maximum (door)step height that you can drive up is 10 cm.
- Avoid driving up slopes $<10^\circ$ for extended periods of time. This can cause excessive wear to the motor and electrical parts.
- Your centre of gravity moves when you go up or down a slope. Be aware of this.
- Turn carefully on a steep slope to avoid the risk of tipping.
- Always drive slowly on steep slopes and pay extra attention.
- Driving down a slope can drastically increase the vehicle's stopping distance



10°



2 PRODUCT DESCRIPTION

1 SCOOZY

- A. Joystick control unit
- B. Armrest
- C. Backrest
- D. Belt receiver
- E. Connection for charger/software
- F. Freewheel lever
- G. Seat belt
- H. Battery cover
- I. License plate holder
- J. Motor transaxle
- K. Daytime running lights & turn signal
- L. Front luggage rack
- M. Headlights (Outdoor only)
- N. Front wheel
- O. Foot platform
- P. Control element (HMI)
- Q. Computer access hatch
- R. Seat

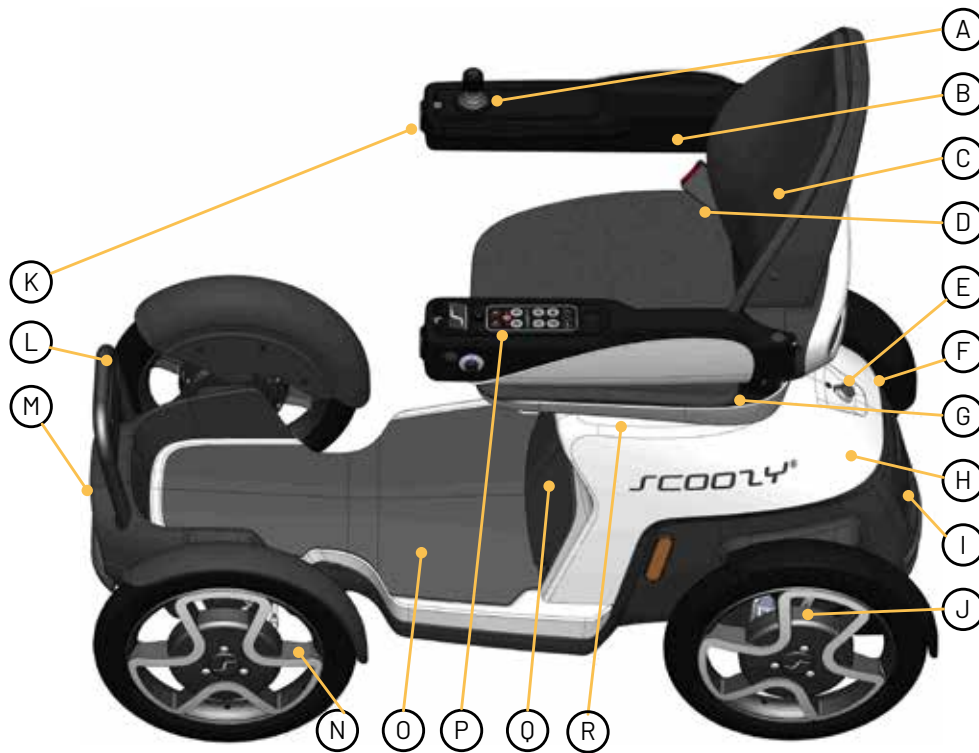



2 CONTROL UNIT

- A. Display
- B. Rear-view mirror
- C. On/off switch
- D. Direction indicator(s)
- E. Emergency stop
- F. D/S indication LED
- G. Speed
- H. Drive
- I. Lighting
- J. Horn
- K. Battery status
- L. Hazard lights
- M. SET
- N. Function
- O. MENU
- P. NFC Ignition switch



3 JOYSTICK CONTROL UNIT

- A. Joystick
 - Forward = Forward / Brake
 - Reverse = Brake / Reverse
 - Left = Turn left
 - Right = Turn right
- B. Armrest lock

2.1 FEATURES

Scoozy is equipped with the following:

- Semi-independent wheel suspension.
- Comfortable seat, with pre-shaped seat and backrest with removable seat cushions.
- Easy operation of doors and joystick.
- Display with speedometer, trip distance and total distance in kilometres.
- Accurate prediction of the number of kilometres still to be driven.
- Data connection for transferring technical data about Scoozy.
- Seat belt, can also be used as an anterior pelvic support

TECHNICAL LIFE

Scoozy attributes a technical lifespan of 6 years to this product.

This means that the product is repairable, safe and usable during this period. The aforementioned statement only applies when the product is used as intended by Scoozy and is CE marked as such, including any original accessories.

In addition, the product must always be maintained according to the manufacturer's instructions.

DATA CONNECTION

Scoozy will send the following data to Scoozy B.V. or its partners:

- Location data per trip;
- Battery status per trip;
- ODO and TRIP data per trip;
- Error codes (when they occur).

This data can only be linked to a Scoozy ID and not to a user. This link can be provided by your dealer. Your dealer can switch off the connection for you.

2.2 INSPECTIONS

The product complies with the following standards:

- EN12184: 2014 Electric Powered Wheelchairs and Scooters, Class C.
- ISO7176-8 Requirements for impact, static and fatigue strength.
- ISO7176-14 Requirements and test methods for controller systems of electrically powered wheelchairs.
- ISO7176-21: 2009 Requirements and test methods for electromagnetic compatibility of electrically powered wheelchairs and motorized scooters.
- EN 1021-2 Requirements for resistance to combustion.

Scoozy is EMC (Electro Magnetic Compatibility) approved.

Tests have shown that Scoozy is not sensitive or harmful to mobile communication equipment and electronically controlled equipment. Nevertheless, be careful when using Scoozy and mobile or electronic devices at the same time.

It is possible that other electrical appliances will be affected by Scoozy (think of shopping gates, electric entrance doors, etc.). Scoozy itself can also be affected by other electrical appliances (e.g. mobile telephones, high voltage pylons, etc.).

2.3 INDICATIONS

1. CE marking

Located on the backrest under the back cushion. It contains various information about the vehicle, the address of the manufacturer and the CE marking.

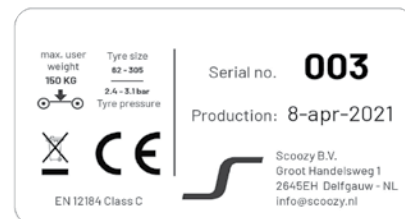

2. Driving restrictions

Located on the backrest under the back cushion. It contains warnings about driving with Scoozy.

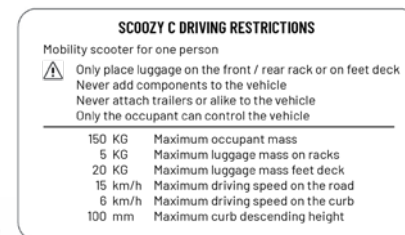

3. Freewheel information

The sticker is located on the back of the right wheel arch. It contains warnings about the use of the freewheel.

If the indications on Scoozy are damaged or not present, please contact the supplier.



2.4 VERSIONS AND ACCESSORIES

VERSIONS

The differences between the versions in which Scoozy C is available are described in the table below:

Version	Range	Drive
Scoozy C	50 km	2WD
Scoozy C XTND	100 km	2WD
Scoozy C 4WD	100 km	4WD



ACCESSOIRES

The following accessories are available for Scoozy C:

- Mirror left and/or right (a)
- Seat rack (b), on which a rollator holder, cane holders and a bag can be attached.
- Cane holder left and/or right (c)
- Luggage rack in the front (d), where a bag can be attached.
- Bag (e), which can be attached to both the seat rack and the front luggage rack.
- Smartphone holder.

Scoozy has four mounting points (M8) on the armrests. These are suitable for mounting mirrors, phone holders and other small accessories.

Consult your Scoozy dealer for advice on the versions and for the purchase and installation of the accessories.

2.5 WEIGHT AND LUGGAGE

Adhere to the following maximum carrying weights:

- Max. 5 kg luggage on the front luggage rack.
- Max. 20 kg luggage on the centre footrest.
- Max. 5 kg luggage on seat rack.
- Max. 150 user weight on the seat.

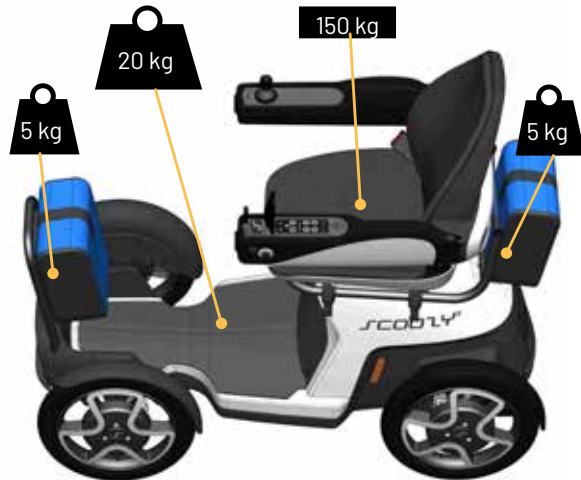

ACCESSOIRES

Scooby has several attachment points for accessories.

To order are:

- Seat rack, including cane holder(s), bag holder and holder for extra accessories such as a rollator holder.
- Front rack high, as holder for a bag

Behind the rear bumper there is an extra connection for accessories from third parties.

WARNINGS

- Never carry more weight than indicated. This leads to very unsafe situations with serious injury or death as a result.
- Never place weight in locations other than indicated.



2.6 BEFORE USE

CHECK DELIVERY

Check whether Scoozy corresponds with the product description in chapter 2. If transport damage is noticed on delivery, this can be reported to the seller.

MAIN SWITCH

Scoozy is activated by pressing the On/Off switch (2C). The computer is always in sleep mode. The Scoozy computer is completely switched off upon delivery by interrupting the power supply with a connector in the High Power cable. When delivering Scoozy, the mechanic switches on Scoozy.

JOYSTICK USE

Scoozy is controlled by a joystick (1A). When grasping the joystick, it is important that the palm of the hand rests on the armrest next to the joystick. The joystick is controlled with a number of fingers. When the joystick is held from the top, the steering is less precise.



3 USE

CHECK BEFORE USE

Check the following before driving off:

- whether there are no defects such as damage, corrosion or other defects on parts;
- the tire pressure;
- whether the freewheel is off (see 3.5);
- whether the battery charger has been removed;
- the operation of the lighting;
- the battery status in the display;

TIRE PRESSURE

For safety reasons, make sure that the Scoozy tire pressure is correct. If the tire pressure is too low, road holding and range deteriorate.

We recommend using the following tire pressure:

- 2.5 bar at a weight of up to 80 kg.
- 3.0 bar at a weight from 80 kg.

TIRE WARNINGS



- Scoozy tires must have sufficient pressure. Check this every ride.
- If the tire pressure is too low, you can drive less far.
- Excessive tire pressure makes driving uncomfortable and increases the risk of a flat tire.
- Check the tires regularly for wear and tear.
- In case of a flat tire, the tire and/or inner tube must be replaced. This can be done by lifting the tire off the rim and replacing it, similar to a bicycle tire.

3.1 DRIVING WITH SCOOZY

STEP IN / STEP OUT

1. Press and hold the armrest button and move outward.
2. Step in or out.
3. Press and hold the door button and move it in until it is straight and the door open indicator on your screen is off.



ENTRY WARNINGS

- Scoozy's wheels steer completely outwards to give you more space to step in.
- Release the button when the door reaches the best position. The door will lock at any position between 0 and 80 degrees

SWITCH ON WITH KEY

1. Activate Scoozy with the On/Off switch (2C).
2. Wait until the key icon appears on the screen with the text "scan key".
3. Place the NFC key on the logo (2P) and wait until the key icon disappears.
4. Close the doors, click the seat belt. The screen displays the battery status and Scoozy is in P mode.



- Several keys can be programmed on one Scoozy by your dealer.
- Product specialists have a special yellow key for changing settings.

DRIVING

Scoozy has 2 speed settings: D and S.

Select a suitable speed setting for every situation:

Speed setting D: Indoors, in stores, and on the pavement.

Speed setting S: On roads and cycle paths.

The maximum speed in D is 6 km/h and in S 15 km/h. It is possible to adjust the maximum speed according to personal preference (see 3.3).

Select the desired setting using the D (2H) and S (2G) buttons. The LED Indicator (2F) will light up above the button of the chosen setting and a D or S will be displayed in the lower left corner of your screen.

In S, the lighting switches on automatically and the brake lights are activated.

BRAKING

Scoozy has 4 ways of stopping:

1. Move the Joystick (3A) to the middle position;
This allows you to roll out gently to 0 km/h. You don't always get the minimum braking distance set in EN 12184.
2. Pull the joystick backwards;
As a result, Scoozy brakes proportionally to 100% braking power.
3. Press the Stop button (2E);
This button has a similar effect to the emergency stop.
4. Put Scoozy in standby with the On/Off switch (2C);
This causes Scoozy to brake mechanically to 0 km/h. Pay attention! The wheels can lock on wet or slippery surfaces

In the event of a major failure of the system, Scoozy will activate the mechanical fail-safe brake. This allows Scoozy to come to a safe stop in any situation.

DRIVING WARNINGS

- Check and dose your speed with the joystick.
- The speed setting determines how fast you go when you move the joystick fully forward.
- With large bumps, you can move the joystick unintentionally and cause unwanted behaviour.
- Check that the road is clear before changing direction.
- Scoozy reverses slower than forward.
- Despite Scoozy's small turning circle, turning in elevators or doors, for example, can be difficult. Make sure that the gear is always in D for short manoeuvres.

BRAKING WARNING

- Scoozy can brake very powerfully!
- With full braking force and poor road surface traction, the wheels of Scoozy can lock. This can lead to reduced control of the vehicle. Always measure your braking force in proportion to your speed, weight and the slope you are going up or down.
- Always hold the joystick with your hand while braking, so you can continue to steer at all times.



3.2 USER MENU



1. The (home) screen in the operator panel displays the following information:
 - The distance to be travelled or the range in kilometres; (a);
 - Speed setting (b);
 - The name of the current screen (c);
 - Eventual icons for the lighting / blinkers / error messages;

2. Press MENU (2D).

Each time you press you will get the following screen:

- The speed in km/h;
- The travelled distance in km;
- The time and date;
- The information menu;
- The settings menu.

To change settings press SET (2M);

3. Push 'stop' (2F).

The screen returns to the home screen with battery status.

3.3 CHANGING SETTINGS

Scoozy can be controlled on 3 skill levels. By default, Scoozy is at level 1 and you can adjust this level at the settings. A technician has even more setting options.

The level can be changed at the control unit. Put Scoozy in P, go to menu > settings and change the level you are driving.



SETTINGS WARNINGS

- Do not change the settings unless you have mastered driving with Scoozy.
- Make sure your eyesight and responsiveness are sufficient to operate Scoozy safely.

Level	1	2	3	Unit
Name	Start	Normal	Advanced	km/u
Speed D				
Min. adjustable	3	3	3	km/u
Standard	4	7	7	km/u
Max. adjustable	6	7	7	km/u
Speed S				
Min. adjustable	6	10	10	km/u
Standard	10	13	15	km/u
Max. adjustable	10	13	15	km/u
Speed R	4	4	4	km/u
Available in	NL BE UK FR	NL BE UK	NL BE	

This diagram can change after software updates. Consult the latest version of the manual at www.en.scoozy.nl.

3.4 JOYSTICK CONTROLS

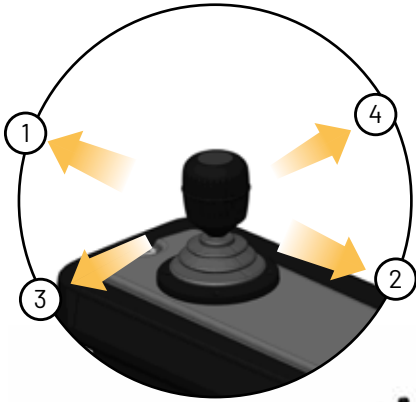

DRIVING FORWARDS

Move the joystick (1A) forward (1) and Scoozy will move forward to drive. Moving the joystick further forward means driving faster.

DRIVING IN REVERSE

1. Move the joystick (1A) backwards (2) and Scoozy will drive in reverse. Moving the joystick further back means reversing faster.
- When Scoozy moves forward and the joystick is pulled back, Scoozy will first slow down to 0 km/h and then reverse.

LEFT / RIGHT

1. Move the joystick (1A) to the left/right (3/4) and the front wheels of Scoozy will steer to the left/right.
2. Move the joystick forward or back to start driving in this direction.

3.5 FREEWHEEL

VENABLING AND DISABLING FREEWHEEL

1. Click the lever on the right rear wheel up to engage the freewheel.
2. Push the lever down again to disengage the freewheel.

Get used to turning the freewheel off after each use.



FREEWHEEL WARNINGS



- Never use this function on a slope or while driving. The magnetic brake will not work, which means that Scoozy can drive freely.
- Scoozy keeps the freewheel speed of the vehicle below 2 km/h. This only works with a connected and working battery.
- Turn off the freewheel after each use of the freewheel function to re-engage the brake.

3.6 OPERATING FUNCTIONS

LIGHTING

1. Press the button (2I) to switch on the lighting.
2. Press the button (2I) again to switch off the lighting. In S mode the lighting is always switched on.

INDICATOR LIGHTS

1. Press the left or right button (2D) to turn on the blinkers on one side of Scoozy.
2. After the wheels have been steered, the indicators switch off automatically.
3. Or press the button again to turn it off.

HAZARD LIGHTS

1. Press the (2L) key to turn on the hazard lights.
2. Press the button (2L) again to turn off the hazard lights.

FUNCTION BUTTON

The function key (2N) functions as a home button in menu navigation.

DAY COUNTER RESET

Go to trip in display with the Menu button (2O). Press the SET key (2M) for > 2 seconds. The numbers on the display flash and go to 00.

BATTERY STATUS

Press the Battery Status button (2K) to immediately see the remaining range in kilometres on the display.

3.7 PARKING AND STORAGE

- Always store Scoozy in a dry, clean place, preferably a garage.
- When storing in a semi-open area (e.g. carport), Scoozy recommends using a storage cover.

WINTER OR LONG-TERM STORAGE (> 3 MONTHS)

- Always charge the Scoozy battery to 100% before storing Scoozy for a longer period of time.
- The computer in the battery always uses energy. Although this power consumption is very low, we recommend charging the battery every 6 months. Longer storage can cause the battery to discharge too much, which can lead to the battery having to be replaced.
- To be sure, the battery can also be disconnected from the computer through the hatch (10). Scoozy will then not use any energy.

WARNINGS



- Always secure Scoozy when storing it by placing a chain lock through one of the wheels. You can tie Scoozy to something for extra security. Always pay attention to what you attach Scoozy to so as not to be a nuisance to anyone.
- Always store batteries fully charged.
- Fully charged batteries can hold their charge for up to six months, but should always be charged before use.
- Avoid storing batteries at extremely high or extremely low temperatures. The ideal temperature is between +20° and +25° Celsius.

3.8 TRANSPORTATION OF SCOOZY

1. Drive Scoozy into the vehicle using the Freewheel (1F).
2. Turn Scoozy off (2C).
3. Make sure Scoozy is properly anchored to the docking points.

DOCKING POINTS

Use the Scoozy fixation eyes (one at the suspension of each wheel) to transport Scoozy safely.

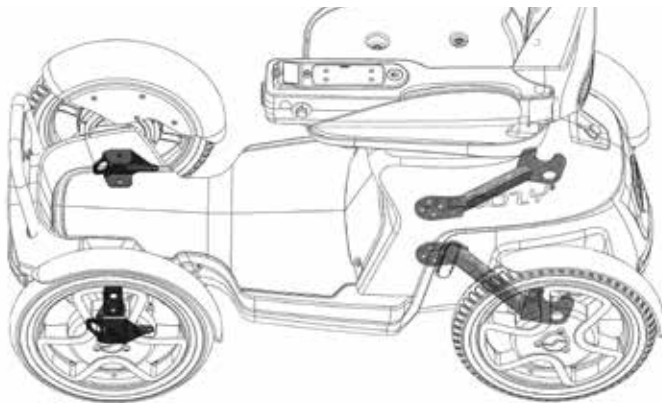

LIFE-THREATENING

When transporting Scoozy in a motorized vehicle, transfer to a fixed seat of the motor vehicle. Scoozy must never be used as a seat support in a motorized vehicle, not even when Scoozy is secured with a taxi lock.



WARNINGS

- Never lift Scoozy by the plastic parts of the housing.
- Scoozy does not comply with the European standard PRM-TSI annex M, so using Scoozy in public transport is not guaranteed.
- Scoozy can be transported in a car, van or trailer.
- Scoozy cannot be made smaller for transportation.



Scoozy is not intended to be used as a seat in a motor vehicle.



LIFTING

Scoozy can be lifted from a lifting eye in the centre of the seat.

The lifting eye is not supplied with Scoozy as standard. To attach the lifting eye, the seat cushion must be removed. The lifting eye can then be turned into the appropriate opening in the centre of the seat.

4 BATTERY

READING THE BATTERY STATUS

On the “battery status” screen you can always see how many kilometres you can still drive with the current battery charge. At a low setting, the following warnings will occur:

- 5-100 You can drive another 5-80 km.
- 4 km The batteries are almost empty, you can only drive in D.
- 2 km The batteries are almost empty, you can only drive in D and you'll hear and see a reminder.
- 1 km You can now only steer with Scoozy, if necessary, use the freewheel (1F) to move Scoozy.

Charge Scoozy as soon as possible at a range below 4km! The advice is to charge the battery within a range of 10 km because of influence of driving conditions on the range.

CHARGING THE BATTERY

Fully charge the batteries at least once every 6 months.

1. Remove the rubber cap from the battery charging socket (F).
2. Insert the plug of the battery charger into the battery

charging socket.

3. The display (A) indicates that Scoozy is in charging mode.
4. Plug the power cord into a wall socket and check if the charger turns on by means of the lights on the charger.
5. The range will increase visibly on the display.
6. When the range on the display has reached 50/100km and the light on the charger indicates 100%, the battery is fully charged.
8. Remove the plug of the battery charger from the wall socket and remove the plug from the battery charging socket.
9. Do not forget to put the rubber cap on the battery charging socket after charging!



SLEEP MODE BATTERY

If Scoozy is not used for more than 24 hours, the battery enters a so-called sleep mode. This is shown on the display as 00km.

You can activate the battery by connecting the battery charger. After waking up the battery, the range with the correct number of kilometres will immediately be shown on the display and you can start driving.

CHARGING TIME

- During charging, the display of Scoozy and the charger shows how full the battery is charged. You can stop charging at any time. The standard battery charges to 80% full in about 5 hours and will then need another 2 hours to reach 100%.
- Unplug the charger when the battery is full. For safety reasons, the charger will not recharge if left plugged in.
- The versions with a double battery pack will take twice as long to fully charge with the same battery charger.

RANGE

Scoozy's range is 50 or 100 km (one or two batteries) when used according to ISO 7176-4: 2008. The range can be reduced during a ride due to:

- The loaded weight (user + luggage);
- The average speed;
- The type of surface you are riding on;
- The degree of hills in the route;
- Climbing pavements.

Ultimately, you may leave with a range of 40 kilometres and after a ride of 20 kilometres, on the trip counter, you'll have another 10 kilometres of range in the battery. So, pay close attention to your odometer and your trip counter during a ride.



BATTERY WARNINGS

- Scoozy has the latest technology Lithium-Ion batteries. The nominal voltage of these batteries is 48V.
 - Prevent the batteries from being completely discharged. Scoozy then stops and that has a negative effect on the lifespan of the battery. With a “deep undervoltage” of one of the battery cells, the battery can no longer be charged and will have to be replaced.
 - Recharge fully discharged batteries as soon as possible.
 - At low temperatures, the batteries have a lower capacity. This reduces the range
 - The battery cannot be charged if the core temperature is below 0° Celsius.
 - It is not possible to overcharge the supplied batteries. Thanks to voltage limitation, the charger switches off automatically when the batteries are full.
 - Be careful with damaged batteries. Leave the (environmentally friendly) replacement of the batteries to your dealer.
- Always fully charge batteries before first use.
 - Only use the Scoozy battery charger supplied. Other chargers can damage the battery.
 - Batteries can be dangerous. Have batteries installed and serviced only by a qualified Scoozy technician. They have the necessary qualifications and tools to carry out installation and maintenance safely and correctly.
 - We strongly advise against driving with Scoozy when the core temperature of the battery is below 0 °C. It is possible that when you drive down a steep slope for a long time, the battery is nevertheless charged. When this occurs frequently, it can cause damage to the battery. This information is logged in the battery and can be read during a possible repair.

4.1 HEATING BATTERY

Scoozy has a resistor to heat the battery and to send braking energy in cold conditions. The battery cannot be charged below 0 °C, so Scoozy will ensure that the battery remains at the right temperature when the outside air is colder than 0 °C. The following situations can occur:

The battery gets colder than 0 °C while driving:

- In this case Scoozy will limit the speed, you will see a snowflake on the screen and Scoozy will try to get the battery back up to temperature with the heater.
- If you left with a battery temperature above 0 °C, we do not expect it to drop. However, we cannot guarantee this at extreme temperatures.
- You can always keep driving in cold conditions. However, Scoozy's speed will be limited by the limited braking power of the resistor. By continuing to drive, the battery heats up the fastest.

The battery is below 0 °C when you turn on Scoozy:

- In this case, you will see the snowflake on the display. Scoozy turns on the heating when the battery is more than 20% charged. If not, Scoozy will not be able to charge or to drive. Then take Scoozy to a warm place.
- How long it takes to warm up the battery depends on the outside temperature and the initial temperature of the battery.
- Whenever possible, we recommend that you store Scoozy in a frost-free area.
- When the charger is plugged in and the battery is still colder than 0 °C, Scoozy will warn you to remove the charger. Charging below 0 °C can seriously damage your battery. The battery temperature can always be read in the info menu > batt. temp.

5. MAINTENANCE

Take Scoozy to your dealer at least once a year for service and inspection. Preventive maintenance checks the proper functioning of all moving parts, the electronics and the condition of the batteries.

Repairs must only be carried out by authorized technicians, using only original parts supplied by Scoozy. An additional service manual is available for licensed technicians with information about faults, installation sequences and more information about the electrical system. Scoozy parts do not need to be periodically replaced, only at signs of wear under the assessment of an authorized Scoozy technician. For instructions on how to replace parts, see service manual.

Replacement for damaged parts and stickers can be ordered from your dealer or at www.en.scoozy.nl/contact.

MAINTENANCE BY USER

- Check Scoozy visually before every ride. Pay attention to the position of the wheels, the fixation of the joystick and the operation of the electrical system. When in doubt, always contact a recognized technician.
- Check the tire pressure before every ride.
- Check the freewheel before every ride (see 3.5).
- Fully charge the battery every month. Allow the charger to balance the battery by leaving it connected for more than 12 hours.
- Check the tread on your tires every six months. Have it replaced in case of severe wear or drying.
- Keep Scoozy clean. To do this, use a damp cloth or rinse with some water. If necessary, use a mild cleaning agent to remove the dirt.

MAINTENANCE BY A TECHNICIAN

During the inspection, a certified technician will check Scoozy for the following points, among other things:

- Visual inspection of bodywork and wheels;
- Check carbon brushes on rear motor;
- Check battery charger operation;
- Check operation and battery condition;
- Check moving parts;
- Check the driving characteristics;
- Check the alignment of the wheels;
- Check for software updates or recalls/advised early replacement;
- Return it clean and functioning properly;
- Prepare a report of the findings.

Mechanics have their own extensive list in the service manual that they follow during maintenance.

CLEANING WARNINGS



- Never use bleach or solvents to clean Scoozy.
- Never use a pressure washer to clean Scoozy.
- Never use thinner, benzene or any other organic solvent to clean Scoozy.
- Clean the cover with a non-abrasive cleaner.
- Clean the upholstery and cover regularly.
- Scoozy cannot be disinfected.



MAINTENANCE WARNINGS

- Only perform the activities explained in this manual. Have other work done by a certified Scoozy technician.
- Do not modify any parts of Scoozy, both mechanical and electronic. Any changes to the mechanical or electrical system will void all warranty.

MECHANICAL FAULTS

The user is the first to notice an unexpected failure. The table below describes some possible defects and their solutions.

Fault	Cause	Solution
Doorknob is difficult to operate	Not used for a long time, oil leak, hose broken	Fully open and close the door 3x, call technician
Rubber mat is loose	Tape is weathered	Apply new double-sided tape, call technician
Scoozy pulls left / right	Steering rod bent, electrical alignment expired	Align steering system, call technician
Wheels vibrate	Wheel attachment is loose, steering gear is loose, wheel internally broken	Call technician
Front wheels have a lot of play when steering	Play on steering system	Call technician

6. NOTIFICATIONS







Take these actions when the display shows a message:

- While in use, see table.
- While driving, see table.





ERROR MESSAGES

1. Read and remember the notification.
2. RESET SCOOPY by restarting it.
3. If the fault persists, contact a dealer / technician.
4. Pass on the report and the number of the error to the dealer.



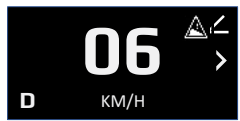

NOTIFICATIONS WHILE IN USE

Notification	Screen	Cause
Armrest	 ARMREST	Close arm properly, Check sensor
Seatbelt	 SEATBELT	Belt not fastened, Sensor cable broken
Joystick	 JOYSTICK	Joystick input too extreme, Use joystick more slowly
Freewheel	 FREEWHEEL	Scoozy cannot drive because the “handbrake” is still released.
Heating	 HEATING...	Scoozy is heating up the battery for driving or charging.
Temp.	 LOW TEMP	Battery is below 0 °C and <20% full. Take Scoozy to a warm place.

NOTIFICATIONS WHILE DRIVING

Notification	Screen	Cause
Slope		Scoozy is on a slope of > 10 degrees, only driving in D is possible.
Battery		After charging you drove a long time down hill. The battery is now too full.
		The battery is very empty, only steering and manual override work.
Temp.		Scoozy is heating the battery. This is up to 0 °C with no driving restrictions, at temperatures below 0 °C Scoozy will limit the speed.

ERROR MESSAGES

Notification	Screen	Cause
Hardware		Electrical failure in hardware, reset Scoozy / contact us.
Software		Software malfunction, reset Scoozy / contact us.
Joystick cable		Joystick cable not properly connected or faulty. Please contact us.
Battery		Computer battery error, reset Scoozy / contact us.

7 WARRANTY CONDITIONS

Scoozy's products are carefully formulated and carefully checked before they leave the factory. If it turns out that Scoozy or any part of it does not meet expectations, you can contact the party where you purchased the product. Scoozy respects consumer protection laws and regulations applicable in the country of purchase.

The warranty does not cover defects caused by: non-observance of operating and maintenance instructions, other than normal use, wear and tear, negligence, overload, accidents by third parties, used, non-original parts and defects that are caused outside the product. With this warranty any other warranty is void; determined by law, or communicated orally, except as guaranteed by Scoozy in writing.

Warranties only apply within the EU.

WARRANTY PROVISIONS

In the warranty and liability provisions, the following terms are defined as follows:

- **Product:** the electric scooter manufactured and supplied by Scoozy.
- **Customer:** the person who directly purchases a product from Scoozy.
- **Dealer:** the person who supplies a product that is involved with Scoozy, to third parties.
- **User:** the person who uses a product manufactured by Scoozy.

Regardless of what has been determined regarding the warranty conditions in the general terms and conditions that apply to the product, the following applies in any case with regard to the warranty:

1. Unless otherwise stated in the terms below, Scoozy warrants the suitability of the product for the purpose for which the product is intended - all of these points as described in this manual - and Scoozy warrants the quality of the material from which the product is made and the way in which the product was produced.
2. Repair or replacement of parts of the product required as a result of defects based on qualitatively defective materials or manufacturing defects will be carried out free of charge, as long as these defects occurred within 2 years from the date of delivery of the product to the Customer. The parts to be replaced must be sent postage paid to Scoozy. Disassembly or assembly of these parts takes place at the expense of the Customer. Therefore, the following cases are not eligible for free repair or replacement as referred to in the previous sentence:
 - a. Repair or replacement necessary in connection with defects that have arisen after more than 2 years from the date of delivery of the product to the Customer;
 - b. Repair or replacement that is necessary in connection with defects resulting from improper or careless use of the product or that are based on the fact that the product has been used for a purpose other than that for which it was intended, in whichever context that applies, if the customer is a Dealer, this Dealer will indemnify Scoozy against any claims from Users or other third parties for defects based on incorrect or careless use of the product;
 - c. Parts subject to wear and tear and the need for repair or replacement of the parts is the actual result of normal wear and tear.

3. Notwithstanding the provisions under 2, insofar as it concerns an electrical product, it applies that with regard to the battery that is part of the product, a warranty is only given in the event of faults or non-functioning of the battery is demonstrably the direct result of material or manufacturing defects. A malfunction or non-functioning of the battery as a result of normal wear and tear is not covered by the warranty as referred to in these warranty provisions. The warranty also excludes defects or non-functioning resulting from improper or inexperienced use of the product or the battery that is part of the product, including incorrect charging of the battery and the inability to perform timely and correct maintenance. In whatever context, if the Customer is a Dealer, this Dealer indemnifies Scoozy against any claims by Users or other third parties based on the above-mentioned improper or injudicious use of the product or battery that is part of the product.
4. The warranty conditions as stated in the above provisions will in any case lapse if:
 - a. the guidelines of Scoozy for the maintenance of the product have not been followed or insufficiently followed;
 - b. a necessary repair or replacement of parts is based on neglect, damage or misuse of the product or use of the product for a purpose other than that for which it was intended;
 - c. parts of the product have been replaced by parts of a different origin than those used by Scoozy and/or parts of the product have been replaced without the permission of Scoozy.
5. The warranties, as stated in clauses 1 to 3, also lapse in the event of re-use by a new user within the warranty period and when such re-use requires modifications to the product and those modifications have not been carried out at the direction and/or under the instructions of Scoozy.

6. In order to retain the rights in accordance with the warranties outlined above, in the event of damage or other calamities, the Customer must contact Scoozy as soon as possible and provide Scoozy with as much information as possible. The option to invoke the aforementioned warranty conditions expires for the Customer in any case after 20 working days after the date of the incident or calamity that forms the basis for the warranty claim.
7. The replacement of a part or the repair or overhaul of the product within a warranty period does not extend the warranty period.
8. Scoozy does not provide any warranty for repair or overhaul of the product that is carried out other than on behalf of and/or under the instruction of Scoozy. If repairs and/or overhauls are carried out by or on behalf of a Customer, the Customer will indemnify Scoozy against any third party claims arising, in the broadest sense, from such repairs or overhauls.

LIABILITY TERMS

Regardless of what is determined with regard to liability in the general terms and conditions that apply to the product, the following applies in any case with regard to liability

Subject to the following provisions, Scoozy only accepts liability for damage by death or physical injury resulting from a defect in the product for which Scoozy is responsible and for damage to another object that is the private property of the user of the product, as long as the damage mentioned is the direct result of an error in the product.

Scoozy does not accept any other or further liability than what is outlined under 1. In particular, Scoozy does not accept any liability for consequential damage, in whatever form.

8 TECHNICAL SPECIFICATIONS

GENERAL SPECIFICATIONS

Max speed.....	15 km/u
Range.....	50 / 100 km
Vehicle weight.....	100 / 110* / 115** kg
Max. user weight.....	150 kg
Max. luggage weight.....	30 kg
Motors.....	Transaxle (+ 2x in-wheel)**
Max. motor power.....	1400W (+ 2x 250W**)
Magnetic brake.....	10 Nm + 1-21 transmission
Wheel size.....	16 inch x 2.5 inch (62/305)
Maximum slope.....	10 °
Battery(type/voltage/content)..	Li-ion / 48V / 33.8-67.6** Ah
Charging time.....	8 km range per charging hour
Max battery charging current....	10A
Supplied charger.....	5A

* In case of a double battery.

** In case of a Scoozy C 4WD.

PRODUCT CHARACTERISTICS

Suspension.....	Semi-independent, 90mm
Luggage placement.....	Racks + foot platform
Seat cushions.....	Removable
Control.....	Joystick left or right
Water resistance.....	Splash proof***

PRODUCT DIMENSIONS

Seat depth.....	440 mm
Seat width.....	450 mm
Seat height.....	410 / 430 / 450 mm
Max. obstacle height.....	100 mm
Distance foot platform-ground..	200 mm
Max. wading depth.....	50 mm
Turning radius.....	1300 mm
Min. corridor width for turning...	2000 mm

*** This means that driving through rain is possible, but Scoozy cannot withstand driving through deep puddles. This can damage the Scoozy on-board computer!

Height 1250 mm

(At: Seat 430 mm + neutral suspension)

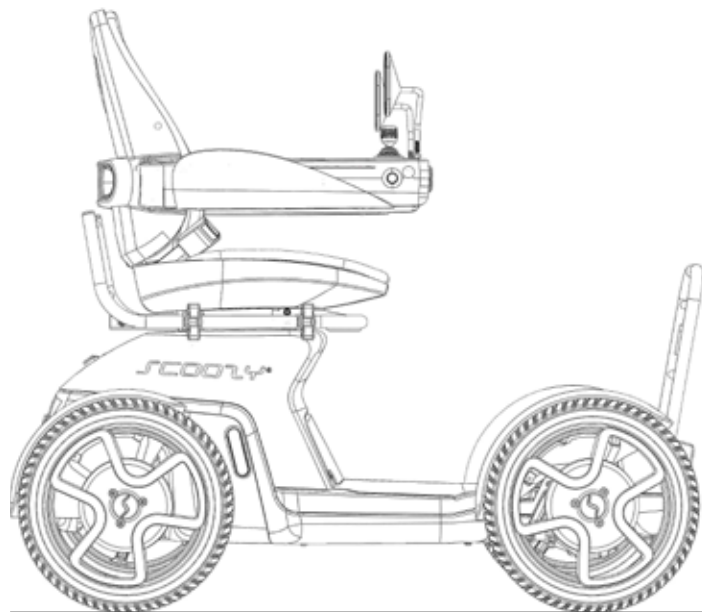

Length 1350 mm

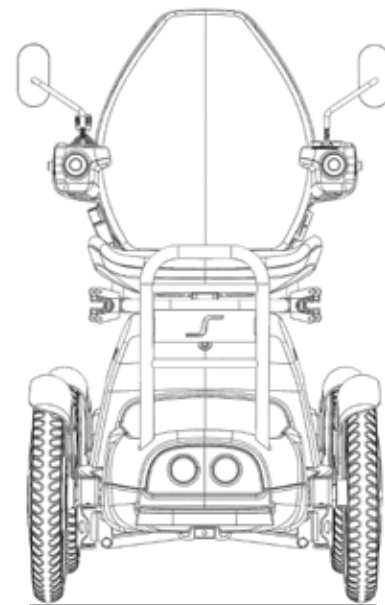

Width 680 mm

excl. accessories

TIRE PRESSURE

User weight up to 80kg..... 2.5 Bar / 36 PSI

User weight up to 150kg..... 3.0 Bar / 44 PSI

9 SPECIFICATIONS TO ISO 7176:15 annex A

	Min.	Max.	
Overall length (including footrest)	-	1350	mm
Overall width (excluding accessories)	-	680	mm
Length folded	n/a	n/a	
Width folded	n/a	n/a	
Height folded	n/a	n/a	
Total mass	100	115	kg
Mass of heaviest part	-	15	kg (seat)
Static stability down hill	-	15	degrees
Static stability up hill	-	15	degrees
Static stability sideways	-	15	degrees
Energy consumption	50	100	km
Dynamic stability uphill	-	10	degrees
Driving up an obstacle	-	100	mm
Maximum forward speed	-	15	km/h
Minimum braking distance at max speed	-	4.5	m

	Min.	Max.	
Seat angle	-	2	degrees
Effective seat depth	-	420	mm
Effective seat width	-	450	mm
Seat height on the front edge in relation to the footplate	420	450	mm
Backrest angle	-	15	degrees
Backrest height	-	550	mm
Footrest to seat distance	-	n/a	mm
Leg to seat angle	-	n/a	mm
Armrest seat height	-	220	mm
Front of armrest to backrest	-	500	mm
Hand hoop diameter	-	n/a	mm
Horizontal location of the axis	-	203	mm
Turning radius to centre of vehicle	-	1300	mm
Mass of test dummy used ISO 7176-22	-	150	kg

10 MAINTENANCE HISTORIE

Inspection upon delivery

Dealer stamp / date / signature

1st annual inspection / 2000 km

Dealer stamp / date / signature

2nd annual inspection / 4000 km

Dealer stamp / date / signature

3rd annual inspection / 6000 km

Dealer stamp / date / signature

4th annual inspection / 8000 km

Dealer stamp / date / signature

5th annual inspection / 10.000 km

Dealer stamp / date / signature

6th annual inspection / 12.000 km
Dealer stamp / date / signature

7th annual inspection / 14.000 km
Dealer stamp / date / signature

Comments:
Scoozy serial:

11 GENERAL

REPORTING INCIDENTS

Report an incident to Scoozy or one of its dealers. Go to www.en.scoozy.nl for the contact details of Scoozy or your dealer. In order to improve product quality and to ensure that our product can be used safely throughout its life, you must submit incident reports. The MDR (Medical Device Regulation) 2017/745 and Annex 9 states the following:

the manufacturer must “encourage users or persons specifically responsible for reporting incidents with medical devices that meet the criteria in this Directive to report incidents to the manufacturer and/or to the competent authority, in accordance with applicable national law and regulations”.

We need your help to meet the requirements and ensure that our products can continue to be used safely. We hope you will never need the information on this page, but should an incident occur, please report it to us.

DISPOSAL OF PRODUCT AND PACKAGING

If your Scoozy is redundant or needs to be replaced, it can usually be taken back by your dealer after consultation. If this is not possible, ask your municipality about the possibilities for reuse or environmentally friendly processing of the used materials. Various plastics and metals have been used for the production of Scoozy.

In addition, Scoozy contains electronic components that belong to electronic waste. The batteries belong to the chemical waste.

From an environmental point of view, we recommend that the packaging and Scoozy be disposed separately as much as possible, so that the used materials can be efficiently recycled



This manual has been compiled with the greatest possible care and is based on the information known to Scoozy at the time of publication. Scoozy accepts no responsibility for any errors in the text or the consequences thereof.

The information in this manual applies to the standard version of the product. Scoozy accepts no responsibility for any damage caused by changes or modifications to the product after the time of first sale. Scoozy can also not be held liable for damage caused by work by third parties.

The information in this manual may not be reproduced and/or published in any way without the prior written consent of Scoozy.

The trade name and trademarks used by Scoozy may not be considered free under trade name law. This text is not legally binding. Subject to modifications.

YOUR DEALER

